



MAZDA

GB	SCUFF PLATES (ILLUMINATED) Installation Instruction
D	EINSTIEGSLEISTEN (BELEUCHTET) Einbauanleitung
E	LISTONES DE UMBRAL (ILUMINADOS) Instrucciones de montaje
F	BASE DE PORTE (ÉCLAIRÉS) Instructions de montage
I	BATTICALCAGNO (ILLUMINATI) Istruzioni di montaggio
P	EMBALADEIRAS (COM ILUMINAÇÃO) Instruções de montagem
NL	DREMPELFOLIES (VERLICHT) Inbouw-instructie
DK	INSTIGNINGSLISTER (BELYST) Monteringsvejledning
N	STIGTRINN (MED LYS) Monteringsveiledning

S	INSTEGLISTER (BELYSTA) Monteringsanvisning
FIN	KYNNYSLISTAT (VALAISTU) Asennusohje
CZ	NASTUPNI LISTY (OSVĚTLENÉ) Návod k montáži
H	KÜSZÖBLÉCEK (MEGVILAGITVA) Beszerelési utasítás
PL	LISTWY PROGOWE (O WISLONE) Instrukcja zabudowy
GR	ΠΡΟΣΤΑΤΕΥΤΙΚΑ ΕΠΙΒΙΒΑΣΗΣ (ΦΩΤΙΣΜΕΝΑ) Οδηγίες τοποθέτησης
RUS	ВХОДНЫЕ ПЛАНКИ (ОСВЕЩАЕМЫЕ) инструкция по установке
SVK	SKUFNE PLOŠČE (OSVETJENE) Návod na inštaláciu



MAZDA 2 HYBRID

ZV

Part Number: ZR74-V1-370

Date: 06-12-2021

© Copyright MAZDA

Sheet 1 of 8

Expert Fitment Required
Montage durch Fachwerkstatt erforderlich
Montaje sólo por el concesionario
Montage par spécialiste nécessaire
E' necessario in officina specializzata
Especialista em montagem requerido
Montage door vakman nodig
Montage ved professionelt værksted påkrævet
Nødvendig med montering fra fagvevkerksted
Verkstadsmontage erfordras
Asennus tarpeen merkkikorjaamossa
Montáž ve specializované dílně nutná
A szereléshez szakmúhely kell
Konieczny montaż przez warsztat specjalistyczny
Να τοποθεί απο συνεργείο
Необходима установка специалистами
Vyžaduje sa odborné vybavenie

INFO

Material Safety Data Sheet



Technical Data Sheet

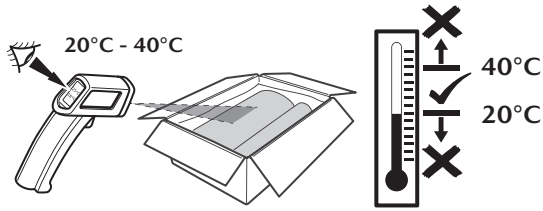
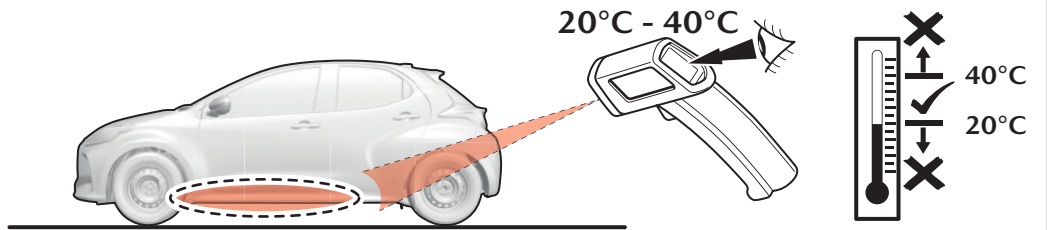

INFO



A
Front LH



B
Front RH



INSTALLATION INSTRUCTIONS

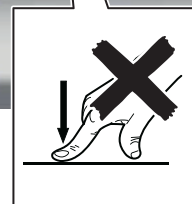
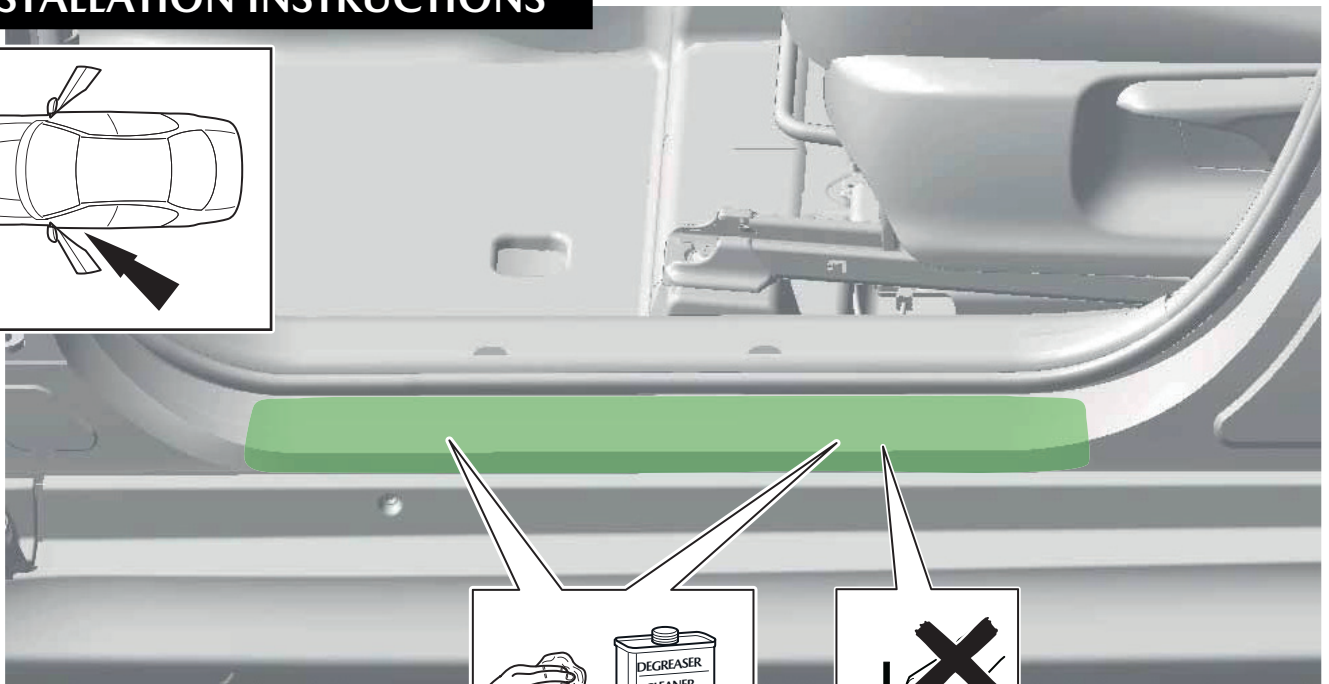
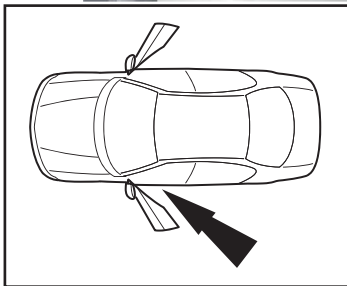

1

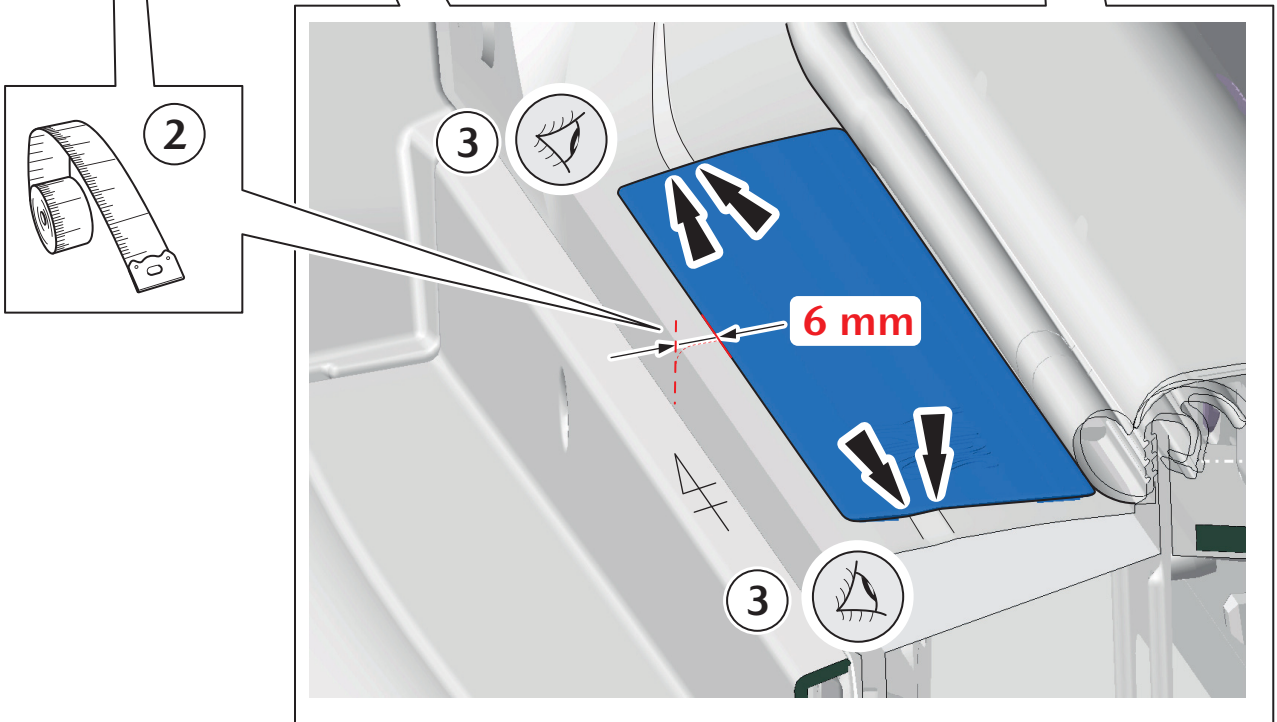
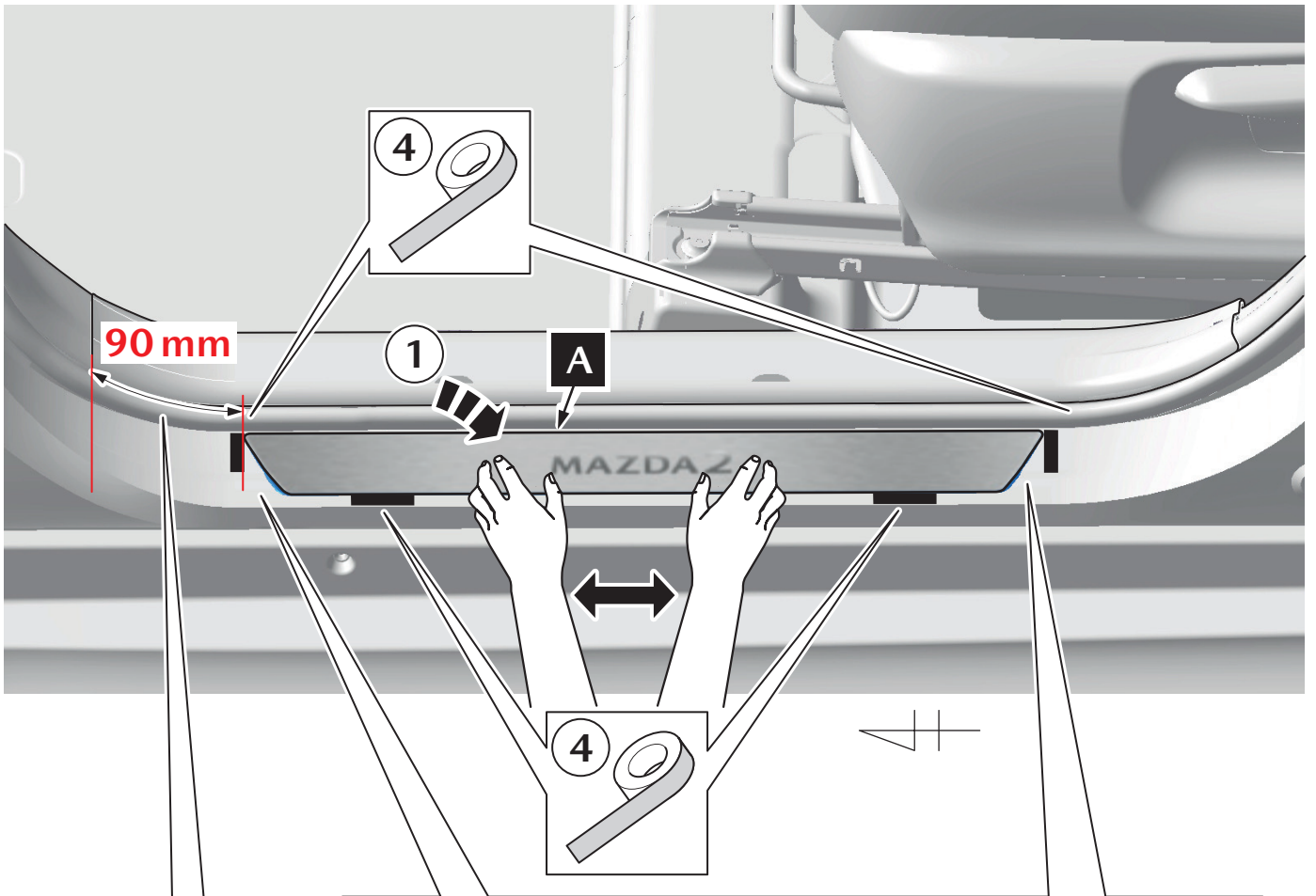

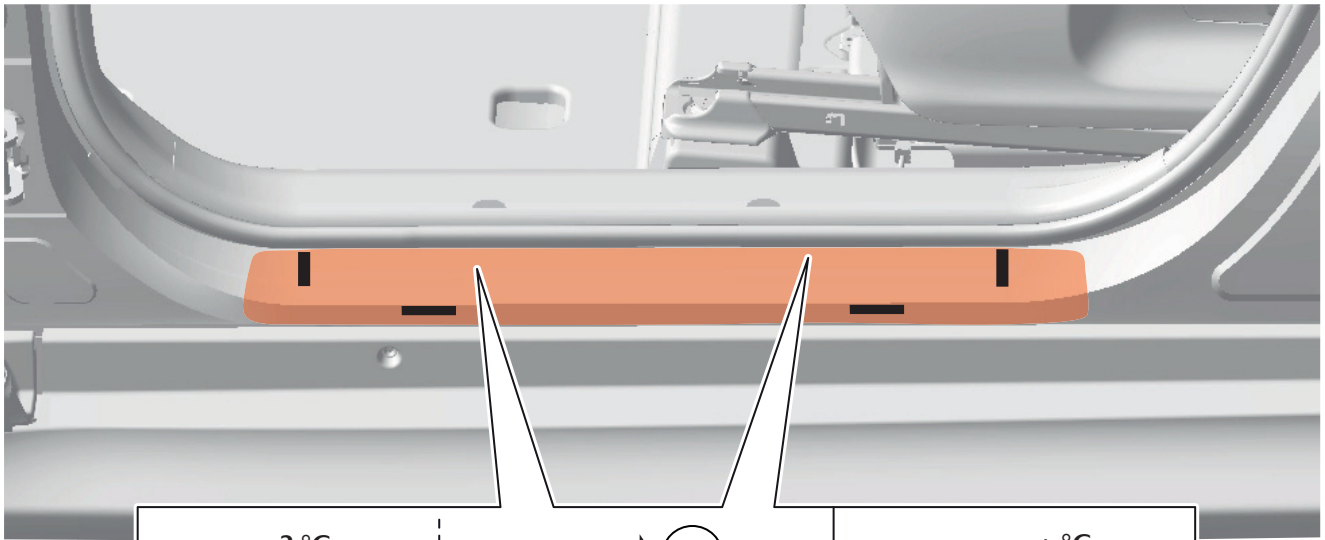

4

<p>①</p>	<p>< 20°C → ②</p> <p>20°C - 40°C → 4</p>	<p>②</p>
<p>③</p>	<p>20°C - 40°C → 4</p>	<p>INFO</p>

3

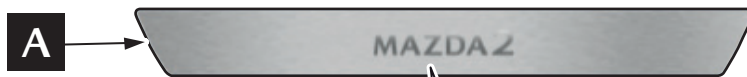

<p>①</p>	<p>< 20°C → ②</p> <p>20°C - 40°C → 5</p>	<p>②</p>
<p>③</p>	<p>20°C - 40°C → 5</p>	<p>INFO</p>

4

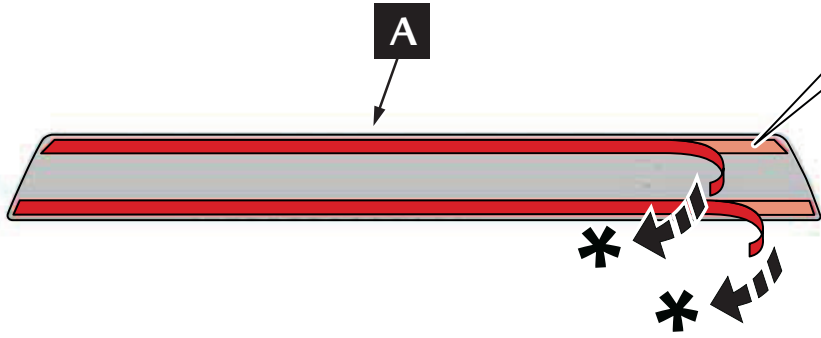
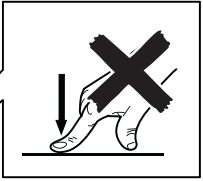
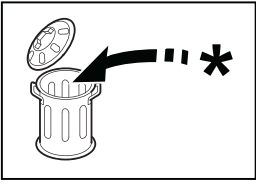

5

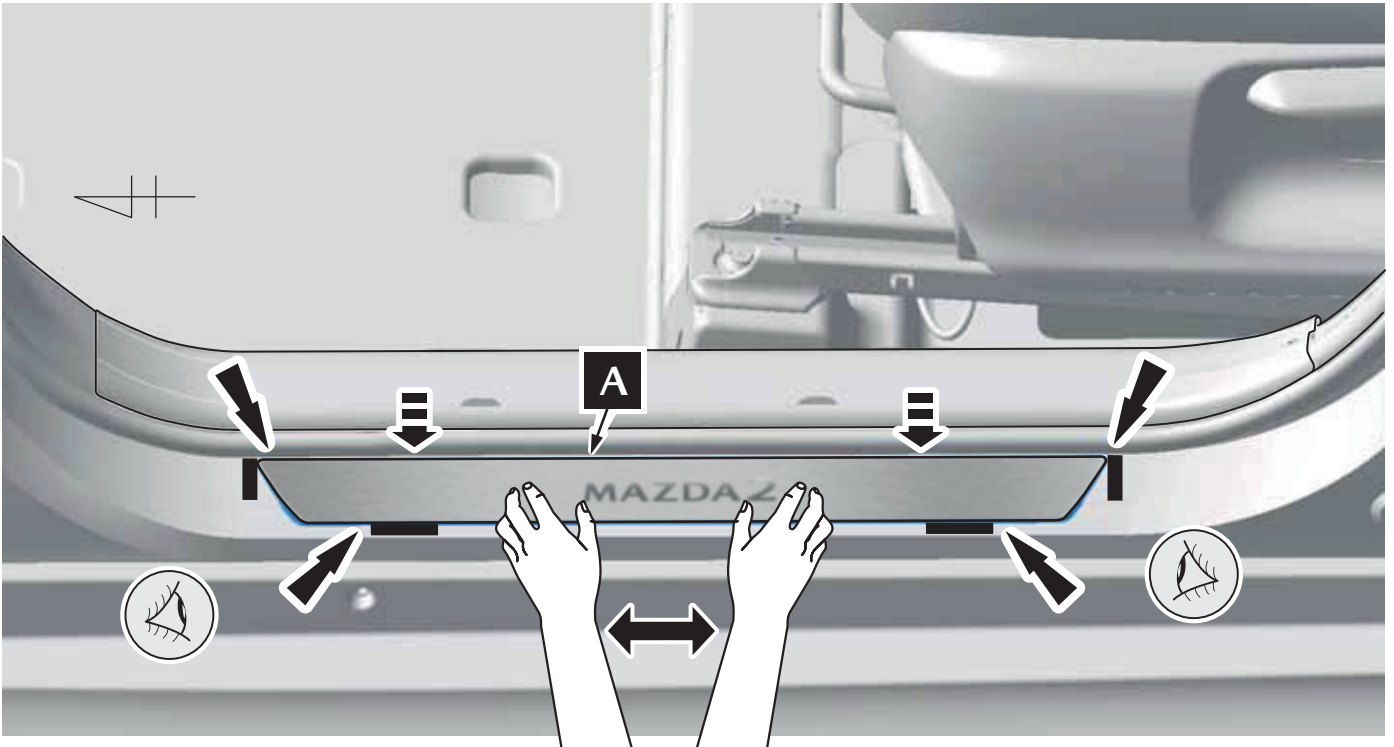

6

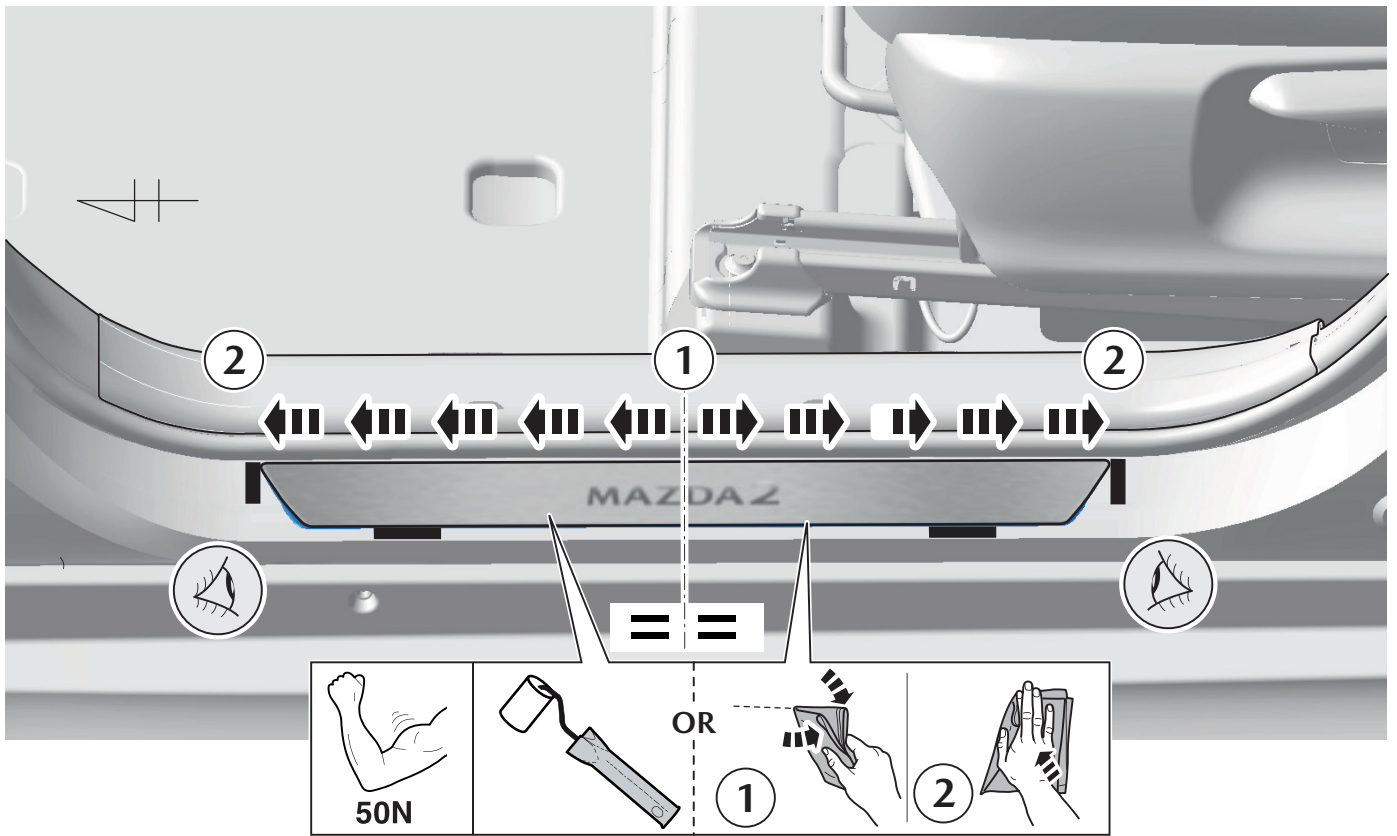

7

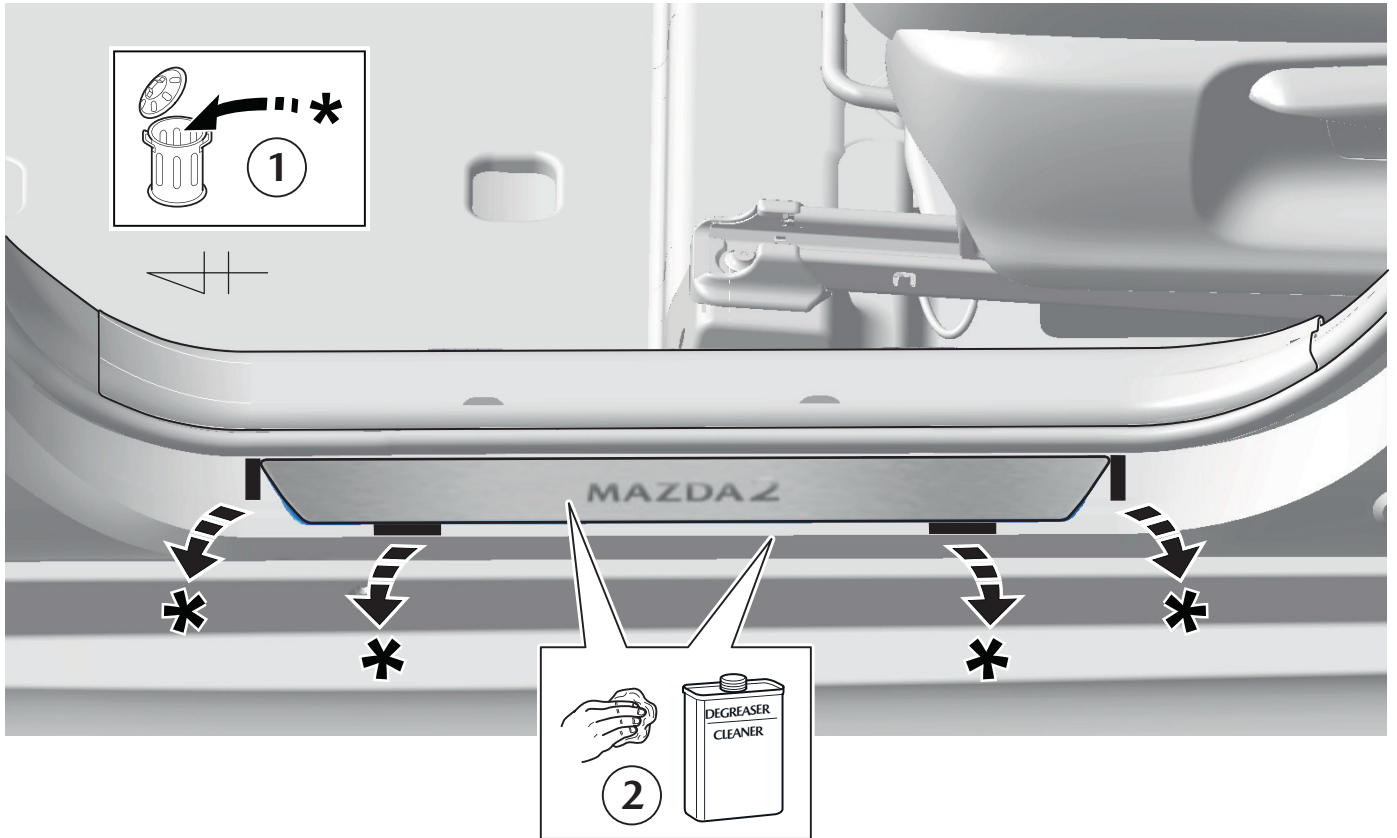

8

RHS = LHS

